

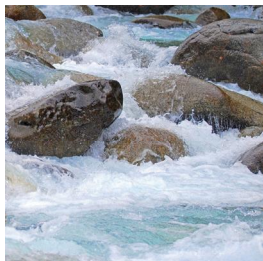

## VASCA IDROMASSAGGIO CON ACCESSO FACILITATO

### ALLESTIMENTI



HYDRO  
HYDRO PLUS

### TUTTE LE FUNZIONI E DOTAZIONI (disponibili a seconda dell'allestimento)

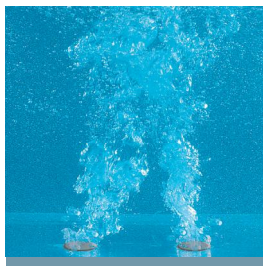

Airpool 16 jets



Whirlpool 6 jets



Disinfezione



Rubinetteria meccanica a bordo vasca



Telecomando Touch Screen

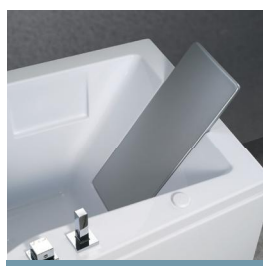

Poggiatesta removibile

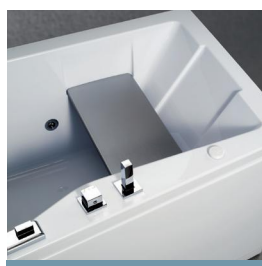

Seduta removibile



Colonna di scarico

#### OPTIONAL



Tubo di scarico salvagoccia

**R90SCDOCBV**



Poggiatesta per versione in nicchia

**POGIRIN**



Sportello per ingresso agevolato, con chiusura meccanica

### FINITURA VASCA

ACRILICO



Bianco lucido

### FINITURA PANNELLI

ACRILICO



Bianco lucido

FINITURA LEGNO

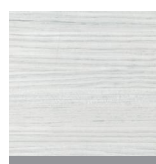

Bianco rigato

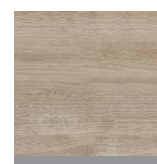

Grain



Burlington



Wenge

# IRIS

VASCA E PANNELLI IN ACRILICO TERMOFORMATATO



Misure		Codice	Scelta scarico/erogazione			Installazione		Struttura / Prezzo			
cm	H		Colonna di scarico	Colonna di scarico con erogatore	Rubinetteria bordo vasca	sinistra	destra	solo telaio	1 pannello	2 pannelli	3 pannelli

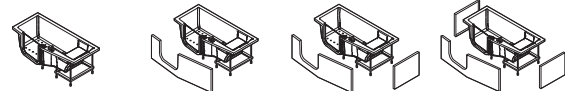

## STANDARD

		C	E	F	S-	D-	A0	A1	A2	A3
160 x 70/80	62									
170 x 70/80				-						
180 x 75/85										

		C	E	F	S-	D-	A0K	A1K	A2K	A3K
160 x 70/80	62									
170 x 70/80		-	-							
180 x 75/85										

## HYDRO



		C	E	F	S-	D-	A0K	A1K	A2K	A3K
160 x 70/80	62									
170 x 70/80										
180 x 75/85										

## HYDRO PLUS



		C	E	F	S-	D-	A0K	A1K	A2K	A3K
160 x 70/80	62									
170 x 70/80										
180 x 75/85										

ESEMPIO COMPILAZIONE CODICE:

IRI417080TCS-A0K

= IRI417080T

+

C

+

S-

+

A0K

# IRIS

VASCA IN ACRILICO TERMOFORMATO E PANNELLI IN FINITURA LEGNO



Misure	Codice	Scelta scarico/erogazione			Installazione		Struttura / Prezzo			Scelta finitura						
		cm	H	Colonna di scarico	Colonna di scarico con erogatore	Rubinetteria bordo vasca	sinistra	destra	1 pannello	2 pannelli	3 pannelli	Acrilico laminato	Legno			
												Bianco lucido	Bianco rigato	Grain	Burlington	Wenge

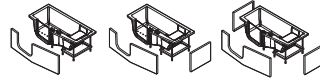

## STANDARD

Misure	Codice	C	E	F	S-	D-	A1	A2	A3	A	I	M	N	V
		160 x 70/80	<b>IRI 2 16070</b>											
170 x 70/80	<b>IRI 2 17080</b>			-										
180 x 75/85	<b>IRI 2 18085</b>													

Misure	Codice	C	E	F	S-	D-	A1	A2	A3	A	I	M	N	V
		160 x 70/80	<b>IRI 2 16070</b>											
170 x 70/80	<b>IRI 2 17080</b>	-	-											
180 x 75/85	<b>IRI 2 18085</b>													

## HYDRO



Misure	Codice	C	E	F	S-	D-	A1	A2	A3	A	I	M	N	V
		160 x 70/80	<b>IRI 3 16070 T</b>											
170 x 70/80	<b>IRI 3 17080 T</b>													
180 x 75/85	<b>IRI 3 18085 T</b>													

## HYDRO PLUS



Misure	Codice	C	E	F	S-	D-	A1	A2	A3	A	I	M	N	V
		160 x 70/80	<b>IRI 4 16070 T</b>											
170 x 70/80	<b>IRI 4 17080 T</b>													
180 x 75/85	<b>IRI 4 18085 T</b>													

ESEMPIO COMPILAZIONE CODICE:

IRI216070CS-A1A

=

IRI216070

+

C

+

S-

+

A1K

+

I

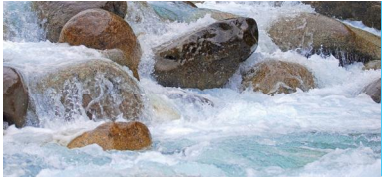

# HYDRO PLUS

IDROMASSAGGIO CLASSICO A GETTO D'ARIA E ACQUA/ARIA



Seduta / Poggiatesta  
removibile



Rubinetteria meccanica  
bordo vasca



Colonna di scarico

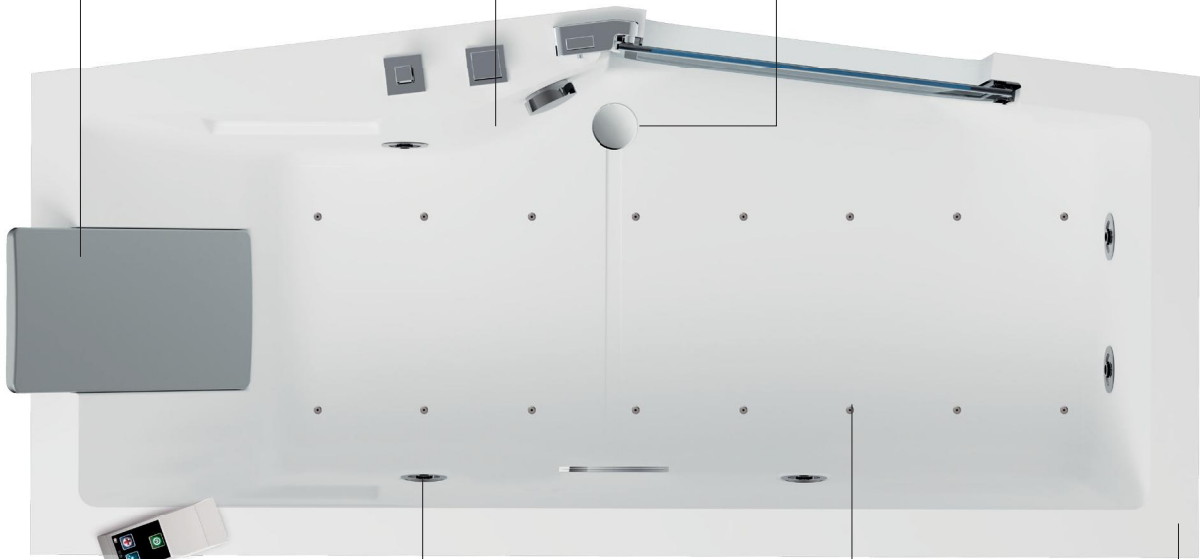

Telecomando  
Touch screen



Whirlpool  
6 jets



Airpool  
16 jets

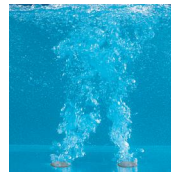

Disinfezione



## FUNZIONI

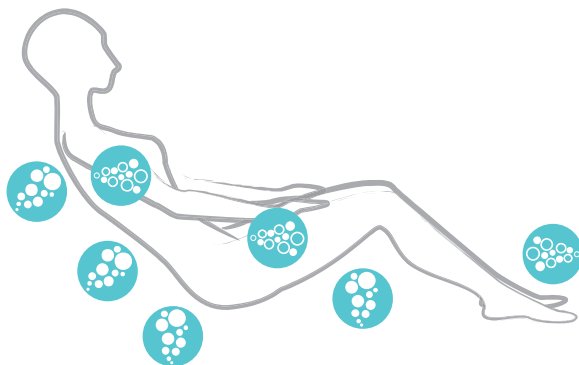

**Massaggio Airpool** a getto d'aria con regolazione manuale on/off o programma sequenziale, per una **efficace stimolazione cellulare**.



**Massaggio corpo Whirlpool** aria/acqua con regolazione di tempo e intensità manuale o automatica. **L'essenzialità del massaggio Novellini**.



# IRIS COMBY

PARETE VASCA COMBINATA ANGOLARE

PER UNA COMBINAZIONE COMPLETA ORDINARE:

- 1 VASCA IRIS
- 1 IRIS COMBY PARETE VASCA COMBINATA

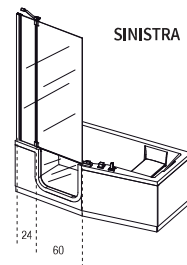

Codice

**IRIS2V80S-1K**

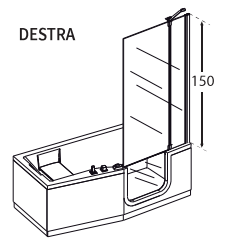

DESTRA

Codice

**IRIS2V80D-1K**



# IRIS COMBY 2

PARETE VASCA COMBINATA CENTRO PARETE

PER UNA COMBINAZIONE COMPLETA ORDINARE:

- 1 VASCA IRIS
- 1 IRIS COMBY 2 PARETE VASCA COMBINATA

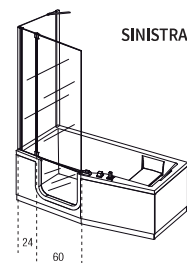

SINISTRA

Fisso

Codice

70 cm **IRIS2VF8070S**

75 cm **IRIS2VF8075S**

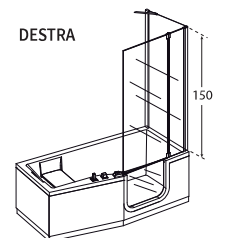

DESTRA

Fisso

Codice

70 cm **IRIS2VF8070D**

75 cm **IRIS2VF8075D**

# DISEGNI TECNICI IRIS (versione sinistra)

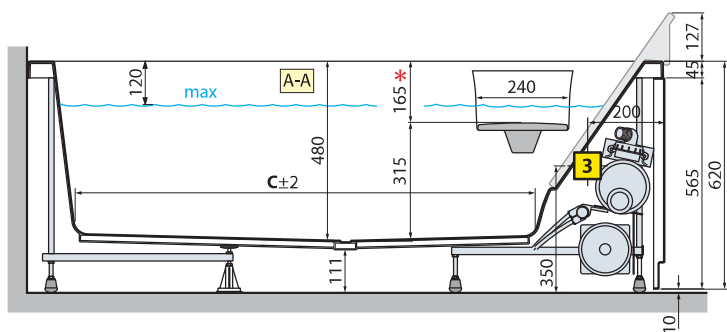

\* 145 mm per il mod. 160x70/80

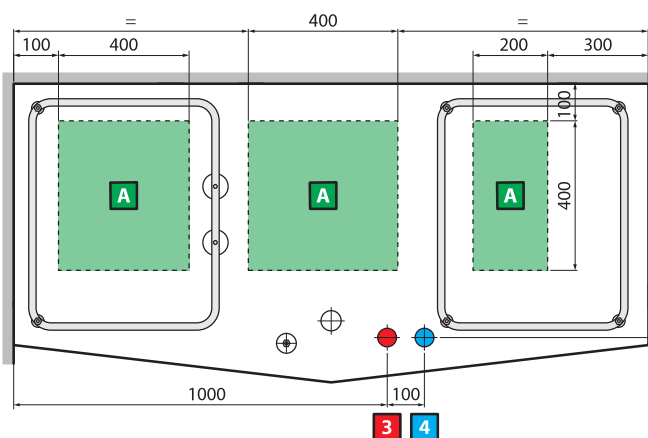
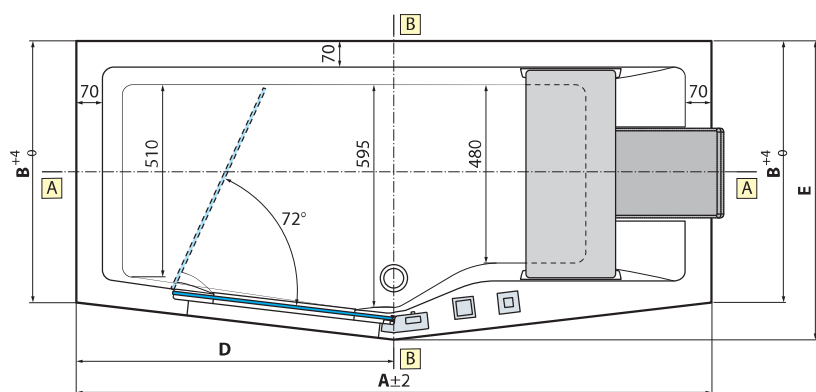
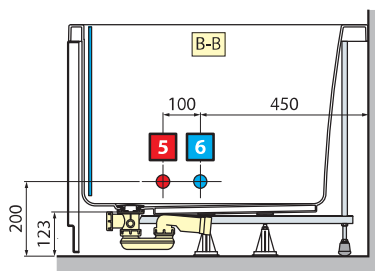
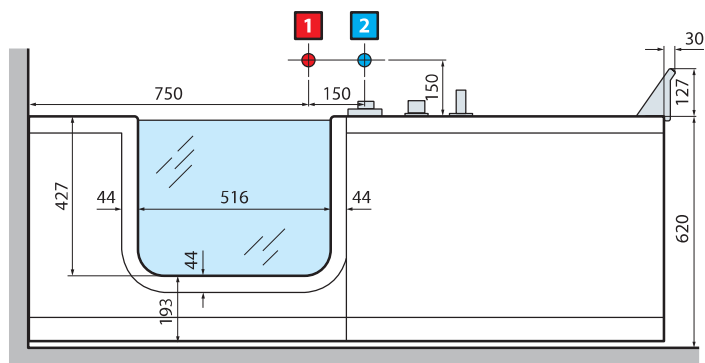

modello	A	B	C	D	E
160x70/80	1600	700	1140	860	800
170x70/80	1700	700	1235	850	800
180x75/85	1800	750	1345	860	850

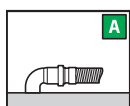

**ATTENZIONE!**  
Può essere dannoso ai portatori di pacemakers

Installare a monte dell'apparecchio un interruttore differenziale da 30mA provvisto di interruttore onnipolare con apertura minima dei contatti  $\geq 3$  mm.

## CARATTERISTICHE IDRAULICHE

6 bocchette whirlpool  
16 bocchette airpool  
Allaccio sifone con raccordo 1 1/2"

## CARATTERISTICHE ELETTRICHE

Tensione 220-230 V  
Frequenza 50 Hz  
Potenza massima assorbita: 950 W  
Whirlpool: 550 W  
Airpool: 400 W

# DISEGNI TECNICI IRIS (versione destra)

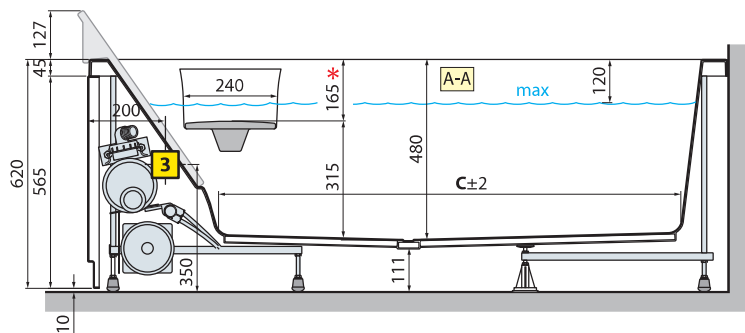

\* 145 mm per il mod. 160x70/80

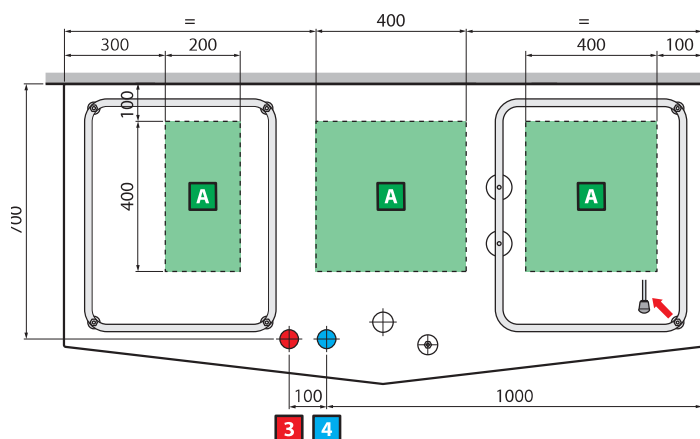
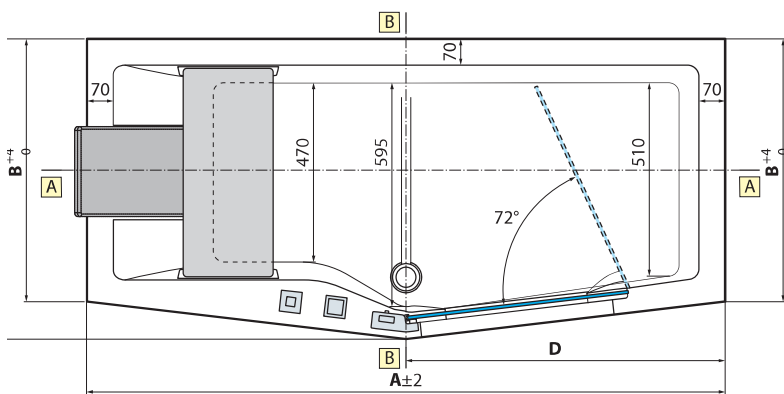
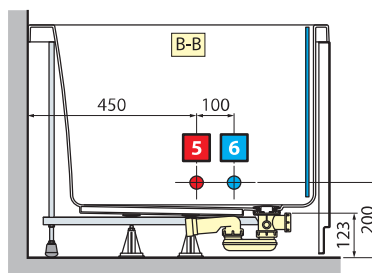
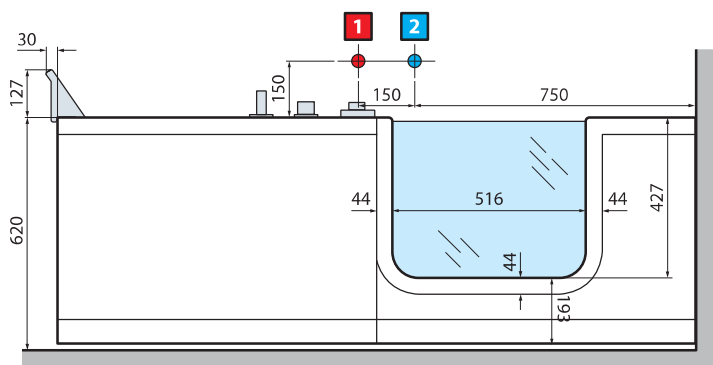

modello	A	B	C	D	E
<b>160x70/80</b>	1600	700	1140	860	800
<b>170x70/80</b>	1700	700	1235	850	800
<b>180x75/85</b>	1800	750	1345	860	850

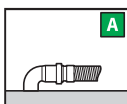

**ATTENZIONE!**  
Può essere dannoso ai portatori di pacemakers

Installare a monte dell'apparecchio un interruttore differenziale da 30mA provvisto di interruttore onnipolare con apertura minima dei contatti  $\geq 3$  mm.

## CARATTERISTICHE IDRAULICHE

6 bocchette whirlpool  
16 bocchette airpool  
Allaccio sifone con raccordo 1 1/2"

## CARATTERISTICHE ELETTRICHE

Tensione 220-230 V  
Frequenza 50 Hz  
Potenza massima assorbita: 950 W  
Whirlpool: 550 W  
Airpool: 400 W