

CALOS



p. 600



150x70 cm	150 lt
160x70 cm	160 lt
170x70 cm	170 lt
170x75 cm	180 lt
170x80 cm	190 lt
180x80 cm	200 lt

VASCA RETTANGOLARE

ALLESTIMENTI

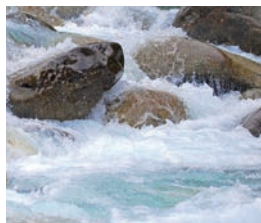

HYDRO
HYDRO PLUS

TUTTE LE FUNZIONI E DOTAZIONI (disponibili a seconda dell'allestimento)



Airpool
16 jets



Whirlpool
6 jets



Disinfezione

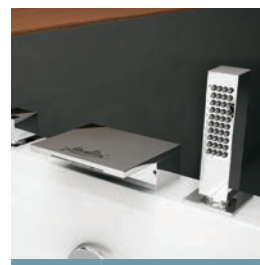

Rubinetteria meccanica a bordo vasca con cascata e doccia



Telecomando Touch Screen



Telecomando ON/OFF



Poggiatesta



Colonna di scarico

FINITURA VASCA ACRILICO



Bianco lucido

OPTIONAL

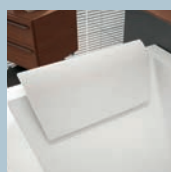

Poggiatesta in EVA (solamente per versione ad incasso)

POGCA1



Tubo di scarico salvagoccia

R90SCDOCBV



Pannello d'ispezione per vasca ad incasso

PANISP-A



Kit piedini regolabili per vasche ad incasso

**PIEDVASCA70
PIEDVASCA75
PIEDVASCA80**

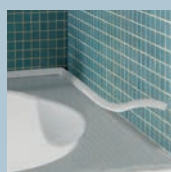

Profilo di finitura

PRVA2-A

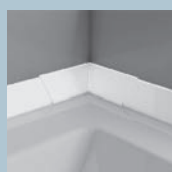

Kit 2 profili di finitura rigidi in plastica 195 cm

PRVA195-30



Profilo di finitura rigido in alluminio

PRV185-30
(1 lato 185 cm)

PRV18585-30
(2 lati 185x85 cm)

PRV8518585-30
(3 lati cm 85x185x85)



Colonna di scarico

COLSCA-K



VASCHE

CALOS

VASCA RETTANGOLARE

Caratteristiche	Misure		Codice	Scelta scarico/erogazione			Scelta struttura / Prezzo			
	cm	H		Colonna di scarico	Colonna di scarico con erogatore	Rubineria bordo vasca	con telaio	1 pannello	2 pannelli	3 pannelli

STANDARD

Caratteristiche	Misure		Codice	Scelta scarico/erogazione			Scelta struttura / Prezzo			
	cm	H		Colonna di scarico	Colonna di scarico con erogatore	Rubineria bordo vasca	con telaio	1 pannello	2 pannelli	3 pannelli
DA INCASSO	150 x 70	58	CA1 1 15070- A	-	-	-		1 pannello	2 pannelli	3 pannelli
	160 x 70		CA1 1 16070- A							
	170 x 70		CA1 1 17070- A							
	170 x 75		CA1 1 17075- A							
	170 x 80		CA1 1 17080- A							
	180 x 80		CA1 1 18080- A							



Caratteristiche	Misure		Codice	Scelta scarico/erogazione			Scelta struttura / Prezzo			
	cm	H		C-	E-	F-	A0	A1	A2	A3
CON TELAIO	150 x 70	58	CA1 2 15070							
	160 x 70		CA1 2 16070							
	170 x 70		CA1 2 17070							
	170 x 75		CA1 2 17075							
	170 x 80		CA1 2 17080							
	180 x 80		CA1 2 18080							

HYDRO



Caratteristiche	Misure		Codice	Scelta scarico/erogazione			Scelta struttura / Prezzo			
	cm	H		C-	E-	F-	A0K	A1K	A2K	A3K
CON TELAIO SENZA DISINFEZIONE	150 x 70	58	CA1 5 15070 O							
	160 x 70		CA1 5 16070 O							
	170 x 70		CA1 5 17070 O							
	170 x 75		CA1 5 17075 O							
	170 x 80		CA1 5 17080 O							
	180 x 80		CA1 5 18080 O							



Caratteristiche	Misure		Codice	Scelta scarico/erogazione			Scelta struttura / Prezzo			
	cm	H		C-	E-	F-	A0K	A1K	A2K	A3K
CON TELAIO E DISINFEZIONE	150 x 70	58	CA1 3 15070 P							
	160 x 70		CA1 3 16070 P							
	170 x 70		CA1 3 17070 P							
	170 x 75		CA1 3 17075 P							
	170 x 80		CA1 3 17080 P							
	180 x 80		CA1 3 18080 P							

HYDRO PLUS



Caratteristiche	Misure		Codice	Scelta scarico/erogazione			Scelta struttura / Prezzo			
	cm	H		C-	E-	F-	A0K	A1K	A2K	A3K
CON TELAIO	150 x 70	58	CA1 4 15070 P							
	160 x 70		CA1 4 16070 P							
	170 x 70		CA1 4 17070 P							
	170 x 75		CA1 4 17075 P							
	170 x 80		CA1 4 17080 P							
	180 x 80		CA1 4 18080 P							

ESEMPIO COMPILAZIONE CODICE:

CA1415070PC-A0K

= CA1415070P + C- + A0K

● Disponibilità indicativa deposito centrale 7gg.



HYDRO PLUS

MASSAGGIO CLASSICO A GETTO D'ARIA E ACQUA/ARIA



FUNZIONI

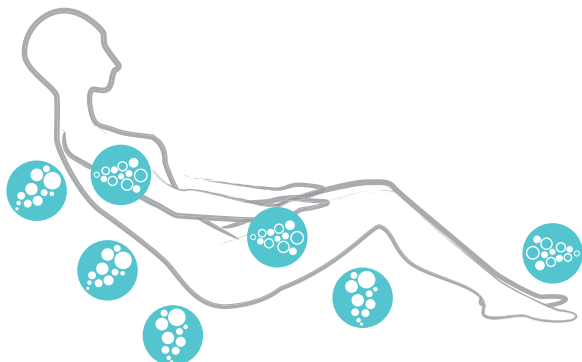

Massaggio Airpool a getto d'aria con regolazione manuale on/off o programma sequenziale, per una **efficace stimolazione cellulare**.



Massaggio corpo Whirlpool aria/acqua con regolazione di tempo e intensità manuale o automatica. **L'essenzialità del massaggio Novellini.**

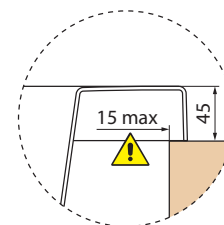
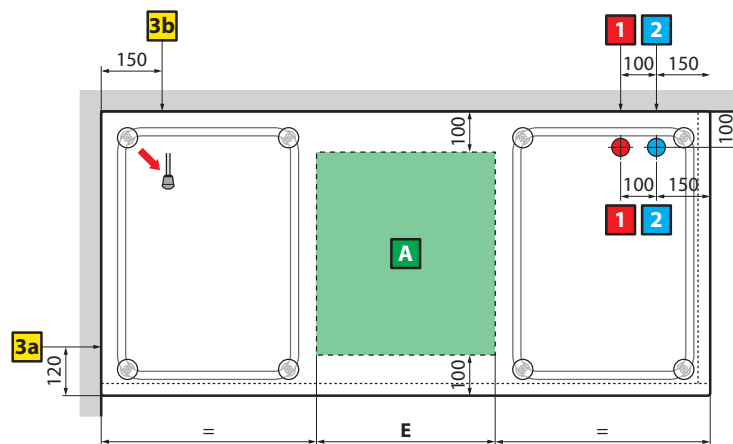
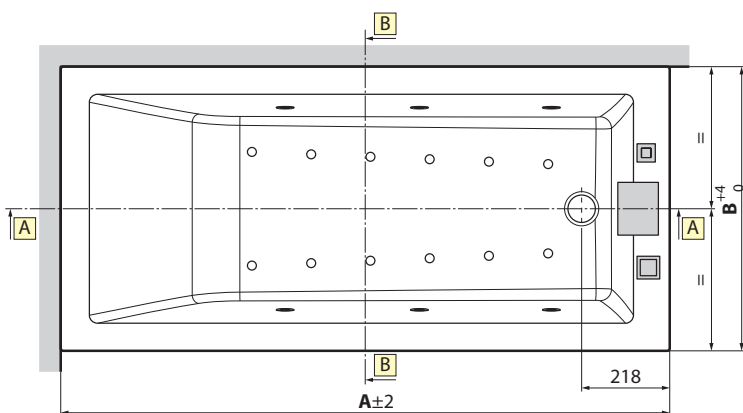
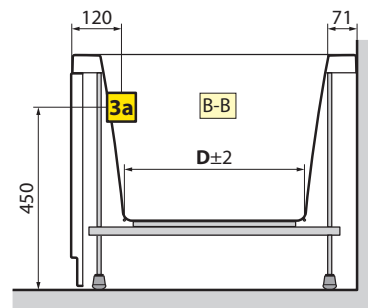
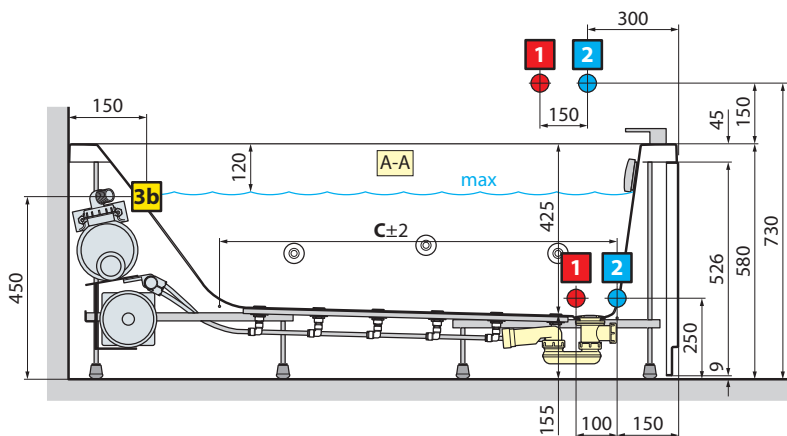

modello	A	B	C	D	E
150x70	1500	700	979	444	300
160x70	1600	700	1081	444	400
170x70	1700	700	1183	444	500
170x75	1700	750	1183	494	500
170x80	1700	800	1183	544	500
180x80	1800	800	1285	544	600

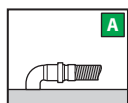

ATTENZIONE!
Può essere dannoso ai portatori di pacemakers

Installare a monte dell'apparecchio un interruttore differenziale da 30mA provvisto di interruttore onnipolare con apertura minima dei contatti ≥ 3 mm.

CARATTERISTICHE IDRAULICHE
6 bocchette whirlpool
12 bocchette airpool
Allaccio sifone con raccordo 1 1/2"

CARATTERISTICHE ELETTRICHE
Tensione 220-230 V
Frequenza 50 Hz
Potenza massima assorbita: 950 W
Whirlpool: 550 W
Airpool: 400 W