



DIVINA C

design Massimo Farinatti



p. 52



140x140 cm 400 lt

VASCA ANGOLARE

ALLESTIMENTI



HYDRO AIR

TUTTE LE FUNZIONI E DOTAZIONI (disponibili a seconda dell'allestimento)

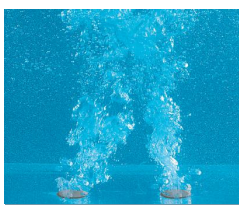

Airpool 16 jets

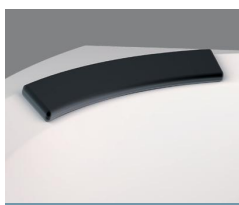

Poggiatesta

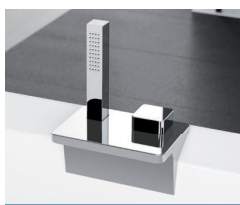

Rubinetteria
bordo vasca

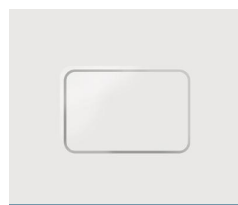

Colonna di
scarico
click-clack



Tubo di scarico
salvagoccia

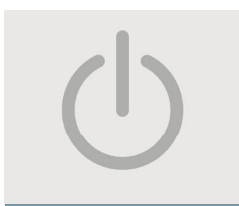

Accensione Soft Touch

PANNELLI

FINITURA LEGNO

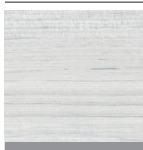

Bianco rigato

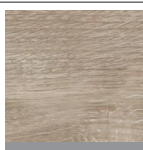

Grain

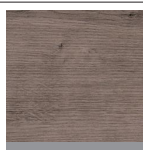

Burlington



Wenge

ACRILICO



Bianco lucido

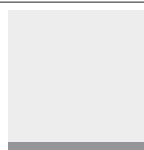

Bianco morbido

OPTIONAL



Mensolina
portaoggetti
bordovasca

R90PODIV



Poggiatesta

POGDIVC



Colonna
rubinetteria a
pavimento

KRUBBAS2-K

DIVINA C

design Massimo Farinatti

VASCA ANGOLARE

Caratteristiche	Misure	Codice	Finitura vasca	Scelta struttura / Prezzo					
	cm H		Lucida Morbida	senza pannelli	1 pannello acrilico (finitura vasca)	Bianco rigato	Grain	Burlington	Wenge

STANDARD

DA INCASSO	140 x 140 63	DIV1140140	-A -U						
------------	--------------	------------	-------	--	--	--	--	--	--



DA INCASSO + RUBINETTERIA A BORDO VASCA	140 x 140 63	DIV11401402	-A0K -U0K						
---	--------------	-------------	-----------	--	--	--	--	--	--



			-A	-U	0	1	1I	1M	1N	1V
CON TELAIO	140 x 140 63	DIV2140140	-A	-U						



			-A	-U	0K	1K	1I	1M	1N	1V
CON TELAIO + RUBINETTERIA A BORDO VASCA	140 x 140 63	DIV21401402	-A	-U						



HYDRO AIR

			-A	-U	0K	1K	1I	1M	1N	1V
CON TELAIO	140 x 140 63	DIV214014000	-A	-U						



			-A	-U	0K	1K	1I	1M	1N	1V
CON TELAIO + RUBINETTERIA A BORDO VASCA	140 x 140 63	DIV214014002	-A	-U						



ESEMPIO COMPILAZIONE CODICE:

DIV2140140-A1I

=

DIV2140140-

+ -A

+ 1I

DIVINA O

design Massimo Farinatti



p. 53



165x94 cm 360 lt

VASCA ANGOLARE ASIMMETRICA

ALLESTIMENTI



HYDRO AIR

TUTTE LE FUNZIONI E DOTAZIONI (disponibili a seconda dell'allestimento)



Airpool 16 jets



Poggiatesta

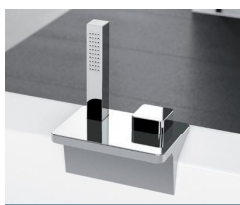

Rubinetteria
bordo vasca

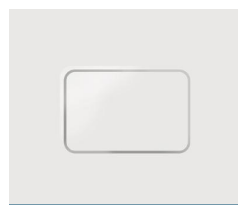

Colonna di
scarico
click-clack

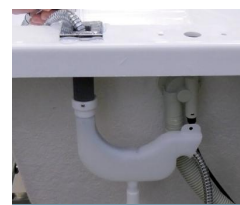

Tubo di scarico
salvagoccia

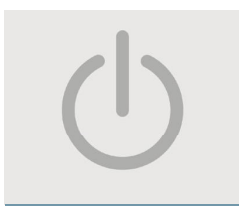

Accensione Soft Touch

PANNELLI

FINITURA LEGNO

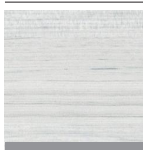

Bianco rigato

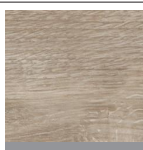

Grain



Burlington



Wenge

ACRILICO



Bianco lucido

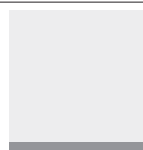

Bianco morbido

OPTIONAL



Mensolina
portaoggetti
bordovasca

R90PODIV



Poggiatesta

POGDIV



Colonna
rubinetteria a
pavimento

KRUBBAS2-K



DIVINA O

DIVINA O

design Massimo Farinatti

S VERS. SINISTRA

D VERS. DESTRA

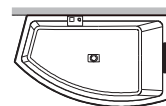
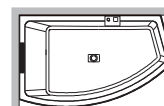

VASCA ANGOLARE ASIMMETRICA

Caratteristiche	Misure	Codice	Installazione	Finitura vasca	Scelta struttura / prezzo					
	cm H		Sinistra Destra	Lucida Morbida	senza pannelli	1 pannello acrilico (finitura vasca)	Bianco rigato	Grain	Burlington	Wenge

STANDARD

DA INCASSO	165 x 94 63	DIV116594	S	D	-A	-U	
------------	-------------	-----------	---	---	----	----	--



DA INCASSO + RUBINETTERIA A BORDO VASCA	165 x 94 63	DIV1165942	S	D	-A0K	-U0K	
---	-------------	------------	---	---	------	------	--



			S	D	-A	-U	0	1	1I	1M	1N	1V
CON TELAIO	165 x 94 63	DIV216594	S	D	-A	-U						



			S	D	-A	-U	0K	1K	1I	1M	1N	1V
CON TELAIO + RUBINETTERIA A BORDO VASCA	165 x 94 63	DIV2165942	S	D	-A	-U						



HYDRO AIR

			S	D	-A	-U	0K	1K	1I	1M	1N	1V
CON TELAIO	165 x 94 63	DIVY1659400	S	D	-A	-U						



			S	D	-A	-U	0K	1K	1I	1M	1N	1V
CON TELAIO + RUBINETTERIA A BORDO VASCA	165 x 94 63	DIVY1659402	S	D	-A	-U						



ESEMPIO COMPILAZIONE CODICE:

DIV216594S-A1

= DIV216594

+ S

+ -A

+ 1

DIVINA

design Massimo Farinatti



p. 54



170x70 cm	280 lt
170x75 cm	300 lt
180x80 cm	350 lt
180x100 cm	430 lt
190x90 cm	420 lt

VASCA RETTANGOLARE

ALLESTIMENTI



HYDRO AIR

TUTTE LE FUNZIONI E DOTAZIONI (disponibili a seconda dell'allestimento)

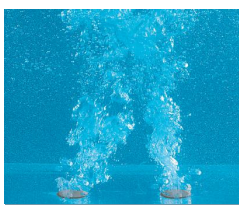

Airpool 16 jets



Poggiatesta

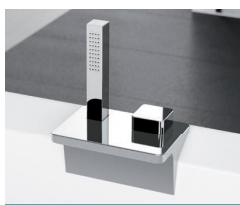

Rubinetteria bordo vasca



Colonna di scarico click-clack



Tubo di scarico salvagoccia

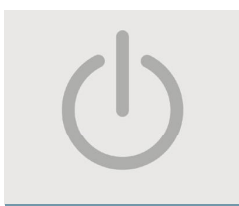

Accensione Soft Touch

PANNELLI

LAMINATO



Bianco lucido

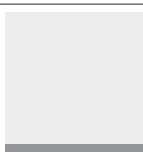

Bianco morbido

FINITURA LEGNO

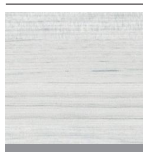

Bianco rigato

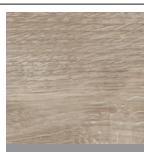

Grain

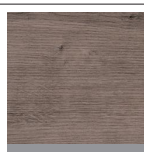

Burlington



Wenge

OPTIONAL



Mensolina portaoggetti bordovasca

R90PODIV

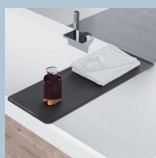

Piano portaoggetti sopra vasca

Larghezza	Codice	Prezzo
70 cm	R90VADIV70	
75 cm	R90VADIV75	
80 cm	R90VADIV80	
90 cm	R90VADIV90	



Poggiatesta

POGDIV



Kit piedini regolabili per vasche ad incasso

PIEDVASCA70
PIEDVASCA75
PIEDVASCA80



Colonna rubinetteria a pavimento

KRUBBVAS2-K



DIVINA

DIVINA

design Massimo Farinatti

VASCA RETTANGOLARE

Caratteristiche	Misure	Codice	Finitura vasca	Scelta struttura / prezzo	Scelta pannelli									
					Laminato			Finitura legno						
	cm H		Lucida Morbida	senza pannelli	1 pannello	2 pannelli	3 pannelli	4 pannelli	Bianco lucido	Bianco morbido	Bianco rigato	Grain	Burlington	Wenge

STANDARD



DA INCASSO	160 x 70	DIV 1 16070	-A	-U		
	170 x 70	DIV 1 17070				
	170 x 75	DIV 1 17075				
	180 x 80	DIV 1 18080				
	180 x 100	DIV 1 18010				
	190 x 90	DIV 1 19090				



DA INCASSO + RUBINETTERIA A BORDO VASCA	160 x 70	DIV 1 16070 2	-A0K	-U0K		
	170 x 70	DIV 1 17070 2				
	170 x 75	DIV 1 17075 2				
	180 x 80	DIV 1 18080 2				
	180 x 100	DIV 1 18010 2				
	190 x 90	DIV 1 19090 2				



CON TELAIO	160 x 70	DIV 2 16070	-A	-U	0	1	2	3	4	A	U	I	M	N	V		
	170 x 70	DIV 2 17070								Bianco lucido	Bianco morbido	Bianco rigato	Grain	Burlington	Wenge		
	170 x 75	DIV 2 17075															
	180 x 80	DIV 2 18080															
	180 x 100	DIV 2 18010															
	190 x 90	DIV 2 19090															



CON TELAIO + RUBINETTERIA A BORDO VASCA	160 x 70	DIV 2 16070 2	-A	-U	0K	1	2	3	4	A	U	I	M	N	V		
	170 x 70	DIV 2 17070 2								Bianco lucido	Bianco morbido	Bianco rigato	Grain	Burlington	Wenge		
	170 x 75	DIV 2 17075 2															
	180 x 80	DIV 2 18080 2															
	180 x 100	DIV 2 18010 2															
	190 x 90	DIV 2 19090 2															

ESEMPIO COMPILAZIONE CODICE:

DIV216070-A1A

=

DIV216070

+

-A

+

1

+

A



DIVINA ▲

Vasca idromassaggio rettangolare

DIVINA

DIVINA

design Massimo Farinatti

VASCA IDROMASSAGGIO RETTANGOLARE

Caratteristiche	Misure	Codice	Finitura vasca		Scelta struttura / prezzo					Scelta pannelli					
			-A	-U	OK	1	2	3	4	Laminato		Finitura legno			
										A	U	I	M	N	V
	cm H		Lucida	Morbida	senza pannelli	1 pannello	2 pannelli	3 pannelli	4 pannelli	Bianco lucido	Bianco morbido	Bianco rigato	Grain	Burlington	Wenge



HYDRO AIR



CON TELAIO	160 x 70	DIV Y 16070 O 0	-A	-U	[Diagram showing 0 panels]					[Material swatches]
	170 x 70	DIV Y 17070 O 0			[Diagram showing 1 panel]					
	170 x 75	DIV Y 17075 O 0			[Diagram showing 2 panels]					
	180 x 80	DIV Y 18080 O 0			[Diagram showing 3 panels]					
	180 x 100	DIV Y 18010 O 0			[Diagram showing 4 panels]					
	190 x 90	DIV Y 19090 O 0			[Diagram showing 4 panels]					



CON TELAIO + RUBINETTERIA A BORDO VASCA	160 x 70	DIV Y 16070 O 2	-A	-U	[Diagram showing 0 panels]					[Material swatches]
	170 x 70	DIV Y 17070 O 2			[Diagram showing 1 panel]					
	170 x 75	DIV Y 17075 O 2			[Diagram showing 2 panels]					
	180 x 80	DIV Y 18080 O 2			[Diagram showing 3 panels]					
	180 x 100	DIV Y 18010 O 2			[Diagram showing 4 panels]					
	190 x 90	DIV Y 19090 O 2			[Diagram showing 4 panels]					

ESEMPIO COMPILAZIONE CODICE:

DIVY1607000-A1A

= DIVY1607000

+ -A

+ 1

+ A

DISEGNI TECNICI DIVINA C

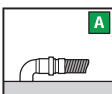
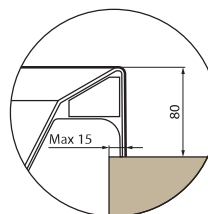
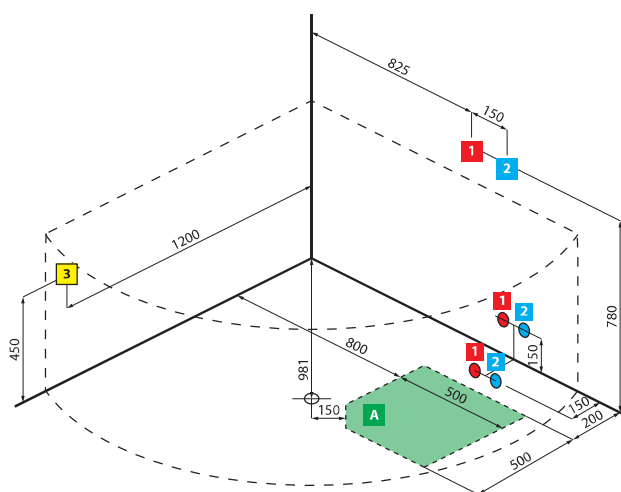
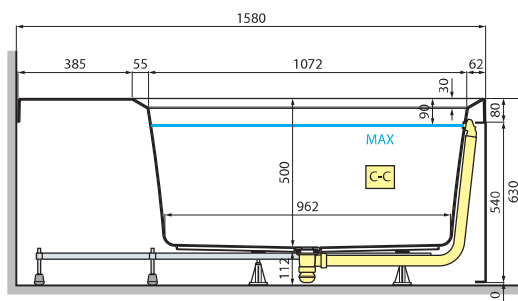
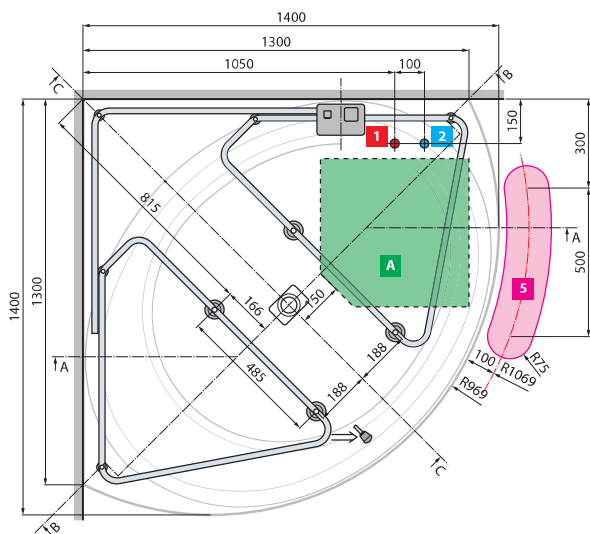
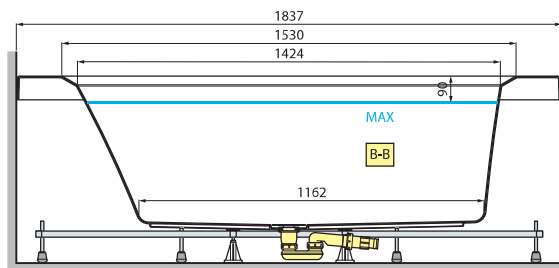
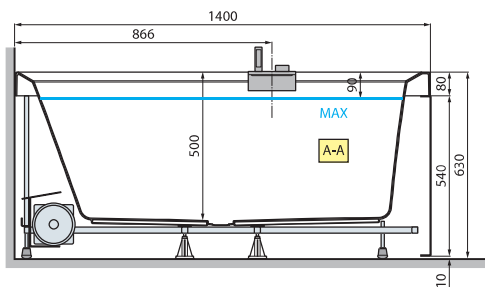

CARATTERISTICHE IDRAULICHE

16 bocchette airpool
Allaccio sifone con raccordo 1 1/2"

CARATTERISTICHE ELETTRICHE

Tensione 220-230 V
Frequenza 50 Hz
Potenza massima assorbita:
airpool 400 W

Installare a monte dell'apparecchio un interruttore differenziale da 30mA provvisto di interruttore onnipolare con apertura minima dei contatti ≥ 3 mm.

DISEGNI TECNICI DIVINA O

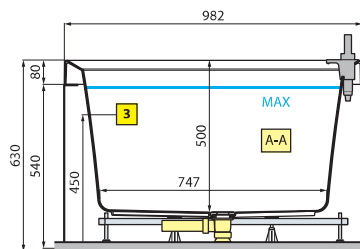
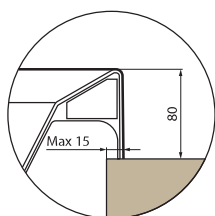
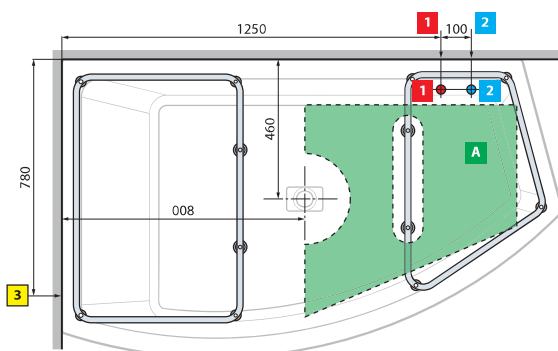
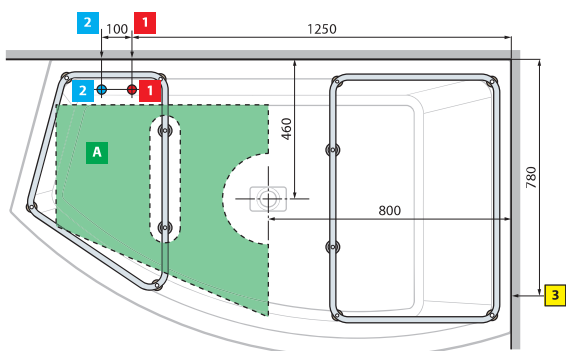
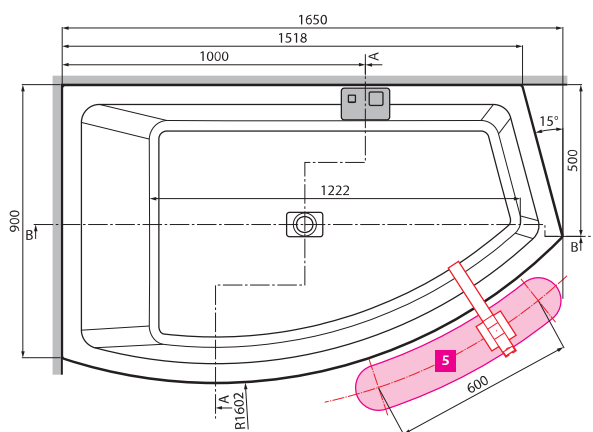
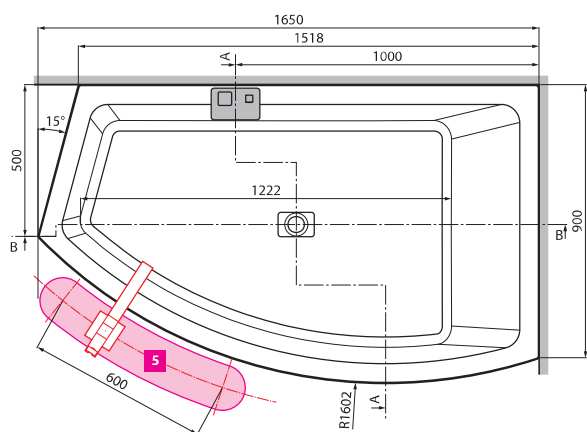
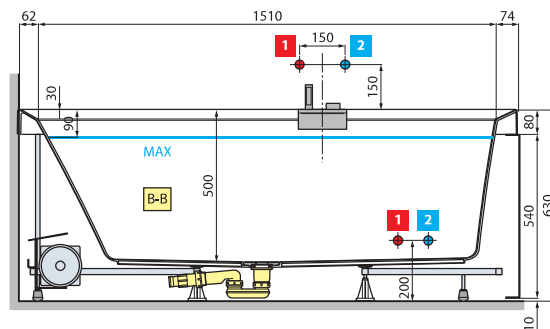
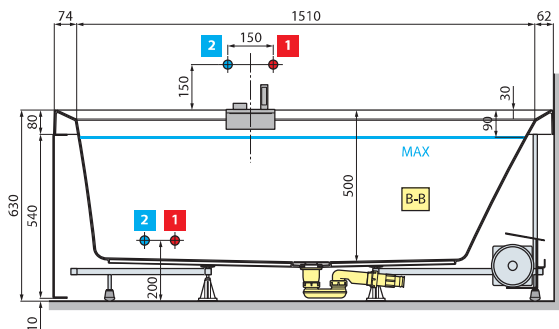

CARATTERISTICHE IDRAULICHE

16 bocchette airpool
Allaccio sifone con raccordo 1 1/2"

CARATTERISTICHE ELETTRICHE

Tensione 220-230 V
Frequenza 50 Hz
Potenza massima assorbita:
airpool 400 W

Installare a monte dell'apparecchio un interruttore differenziale da 30mA provvisto di interruttore onnipolare con apertura minima dei contatti ≥ 3 mm.

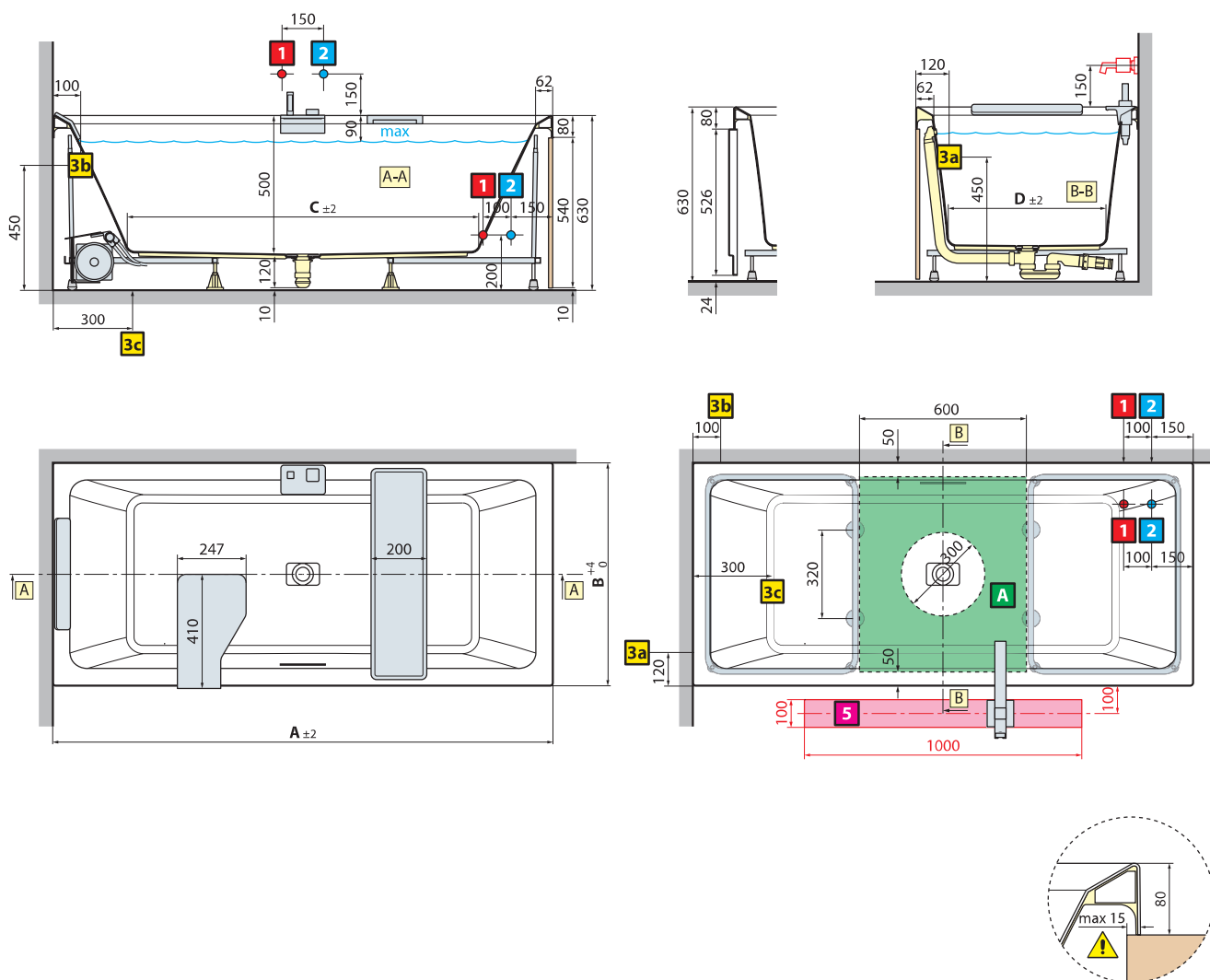

modello	A	B	C	D
160x70	1600	700	1050	460
170x70	1700	700	1150	460
170x75	1700	750	1150	510
180x80	1800	800	1250	560
180x100	1800	1000	1250	760
190x90	1900	900	1350	660

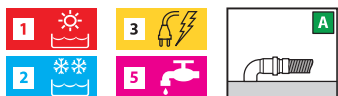

CARATTERISTICHE IDRAULICHE

16 bocchette airpool
Allaccio sifone con raccordo 1 1/2"

CARATTERISTICHE ELETTRICHE

Tensione 220-230 V
Frequenza 50 Hz
Potenza massima assorbita:
airpool 400 W

Installare a monte dell'apparecchio un interruttore differenziale da 30mA provvisto di interruttore onnipolare con apertura minima dei contatti ≥ 3 mm.