

# SENSE 6

COLLEZIONE *elysium*



p. 594



<b>170x70</b> cm	<b>180</b> lt
<b>180x80</b> cm	<b>220</b> lt
<b>190x80</b> cm	<b>230</b> lt

VASCA RETTANGOLARE

## ALLESTIMENTI



**HYDRO**  
**HYDRO PLUS**

**TUTTE LE FUNZIONI E DOTAZIONI DISPONIBILI (disponibili a seconda dell'allestimento)**



 Airpool  
12 jets



 Whirlpool  
4 jets

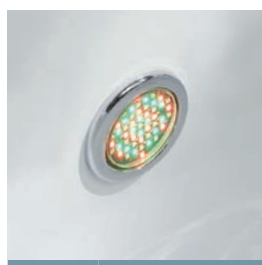

 Cromolight

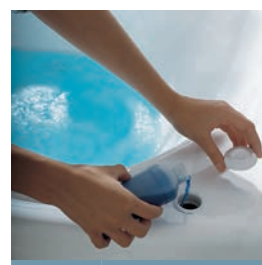

 Disinfezione

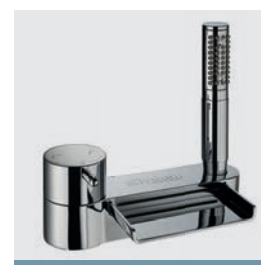

 Rubinetteria  
meccanica a  
bordo vasca  
con cascata e  
doccetta



 Pannello  
elettronico  
con funzioni  
Hydro sequence



 Poggiatesta

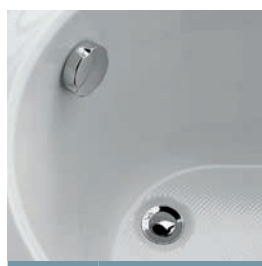

 Colonna  
di scarico

## FINITURA VASCA ACRILICO



Bianco lucido

## OPTIONAL

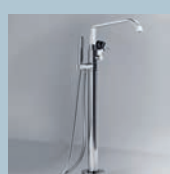

Rubinetteria  
meccanica  
montaggio a  
pavimento  
**KRUBBVAS-K**



Colonna di  
scarico  
**COLSCAVK-K**



Pannello  
d'ispezione per  
vasca ad incasso  
**PANISPEL-A**



Kit piedini  
regolabili per  
vasche ad incasso  
**PIEDVASCA**



Profilo  
di finitura  
**PRV185-30**  
(1 lato 185 cm)

**PRV18585-30**  
(2 lati 185x85 cm)



▲ **SENSE 6**  
vasca rettangolare

# SENSE 6

VERSIONE SINISTRA    VERSIONE DESTRA



## VASCA RETTANGOLARE

Caratteristiche	Misure		Installa- zione	Codice	Scelta struttura / Prezzo			
	cm	H			senza pannelli	1 pannello	2 pannelli	3 pannelli

### STANDARD

				A			
DA INCASSO	170 x 70	58	<b>Y1 17070-</b>		-	-	-
	180 x 80		<b>Y1 18080-</b>				
	190 x 80		<b>Y1 19080-</b>				
DA INCASSO CON RUBINETTERIA BORDO VASCA	170 x 70	58	<b>D</b> <b>Y1 17070 D2-</b>		-	-	-
	180 x 80		<b>S</b> <b>Y1 17070 S2-</b>				
			<b>D</b> <b>Y1 18080 D2-</b>				
	190 x 80		<b>S</b> <b>Y1 18080 S2-</b>				
			<b>D</b> <b>Y1 19080 D2-</b>				
			<b>S</b> <b>Y1 19080 S2-</b>				

					A1	A2	A3
CON TELAIO	170 x 70	58	<b>Y2 17070-</b>	-			
	180 x 80		<b>Y2 18080-</b>				
	190 x 80		<b>Y2 19080-</b>				
CON TELAIO E RUBINETTERIA BORDO VASCA	170 x 70	58	<b>D</b> <b>Y2 17070 D2-</b>	-			
	180 x 80		<b>S</b> <b>Y2 17070 S2-</b>				
			<b>D</b> <b>Y2 18080 D2-</b>				
	190 x 80		<b>S</b> <b>Y2 18080 S2-</b>				
			<b>D</b> <b>Y2 19080 D2-</b>				
			<b>S</b> <b>Y2 19080 S2-</b>				

### HYDRO

				A0K	A1K	A2K	A3K
CON TELAIO	170 x 70	58	<b>D</b> <b>Y5 17070 R D0-</b>				
	180 x 80		<b>S</b> <b>Y5 17070 R S0-</b>				
			<b>D</b> <b>Y5 18080 R D0-</b>				
	190 x 80		<b>S</b> <b>Y5 18080 R S0-</b>				
			<b>D</b> <b>Y5 19080 R D0-</b>				
			<b>S</b> <b>Y5 19080 R S0-</b>				
CON TELAIO E RUBINETTERIA BORDO VASCA	170 x 70	58	<b>D</b> <b>Y5 17070 R D2-</b>				
	180 x 80		<b>S</b> <b>Y5 17070 R S2-</b>				
			<b>D</b> <b>Y5 18080 R D2-</b>				
	190 x 80		<b>S</b> <b>Y5 18080 R S2-</b>				
			<b>D</b> <b>Y5 19080 R D2-</b>				
			<b>S</b> <b>Y5 19080 R S2-</b>				

### HYDRO PLUS

				A0K	A1K	A2K	A3K
CON TELAIO	170 x 70	58	<b>D</b> <b>Y7 17070 R D6-</b>				
	180 x 80		<b>S</b> <b>Y7 17070 R S6-</b>				
			<b>D</b> <b>Y7 18080 R D6-</b>				
	190 x 80		<b>S</b> <b>Y7 18080 R S6-</b>				
			<b>D</b> <b>Y7 19080 R D6-</b>				
			<b>S</b> <b>Y7 19080 R S6-</b>				
CON TELAIO E RUBINETTERIA BORDO VASCA	170 x 70	58	<b>D</b> <b>Y7 17070 R D7-</b>				
	180 x 80		<b>S</b> <b>Y7 17070 R S7-</b>				
			<b>D</b> <b>Y7 18080 R D7-</b>				
	190 x 80		<b>S</b> <b>Y7 18080 R S7-</b>				
			<b>D</b> <b>Y7 19080 R D7-</b>				
			<b>S</b> <b>Y7 19080 R S7-</b>				

ESEMPIO COMPILAZIONE CODICE:

Y719080RD7-A0K

=

Y719080RD7-

+

A0K



# HYDRO PLUS

MASSAGGIO CLASSICO A GETTO D'ARIA E ACQUA/ARIA

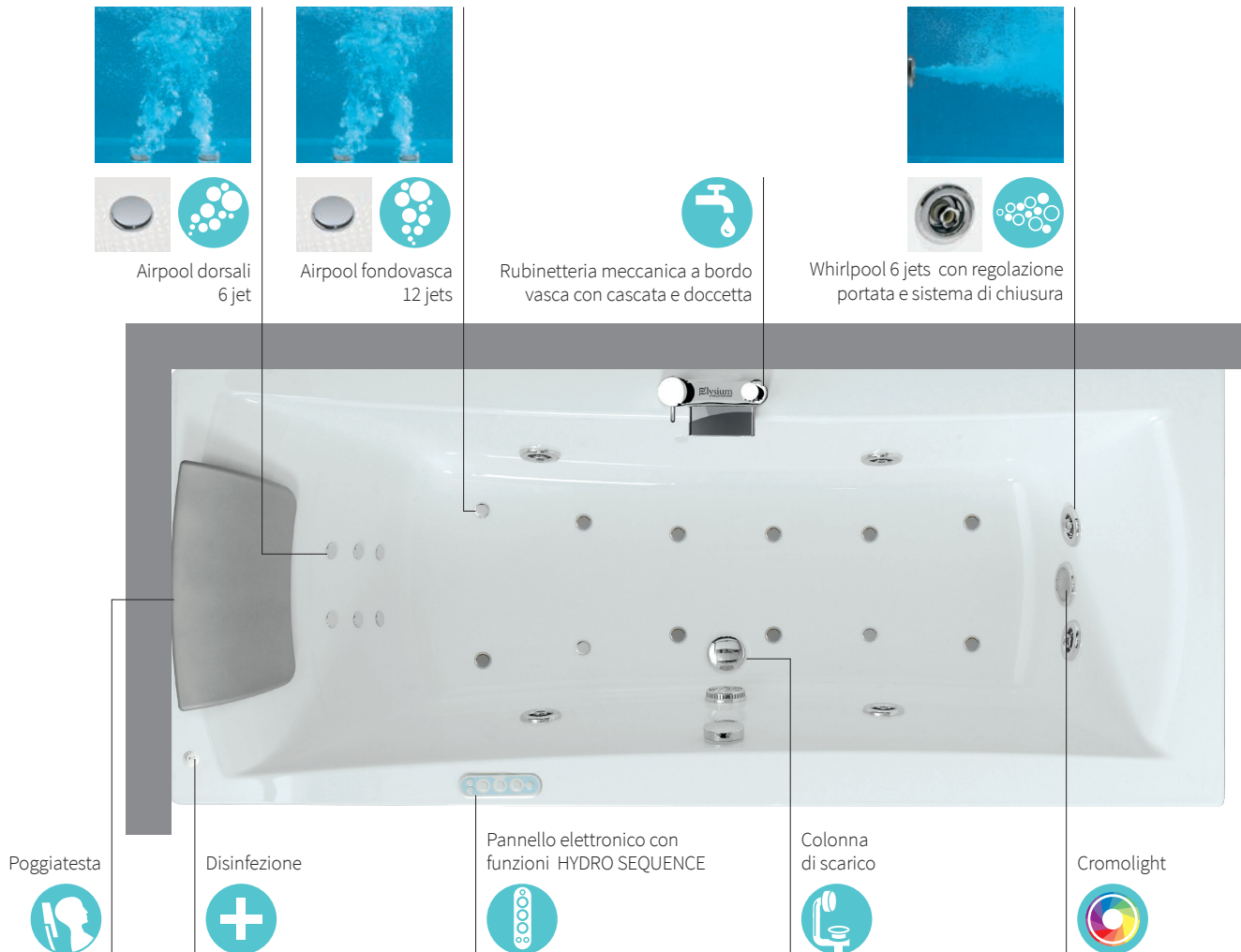

## FUNZIONI

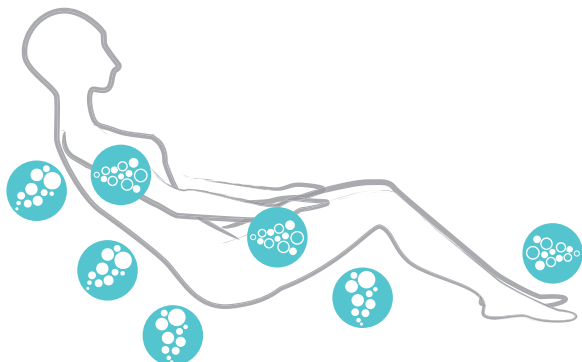

**Massaggio Airpool** a getto d'aria con regolazione manuale on/off o programma sequenziale, per una **efficace stimolazione cellulare**.



**Massaggio corpo Whirlpool** aria/acqua con regolazione di tempo e intensità manuale o automatica. **L'essenzialità del massaggio Novellini**.



**Programmi 4 stagioni Cromolight**. Una sinfonia di luci e colori per un crescendo di **emozioni sensoriali**.

# DISEGNI TECNICI SENSE 6

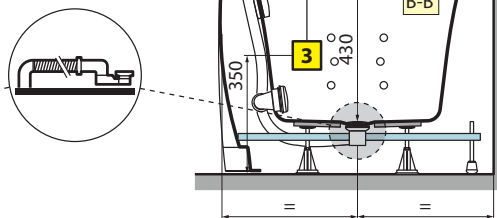
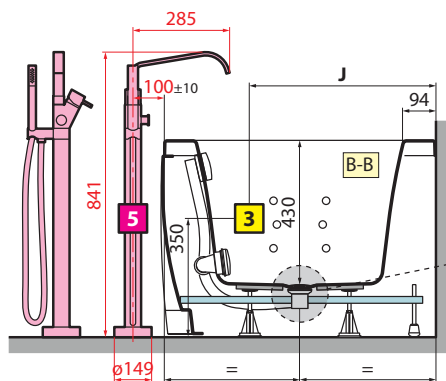
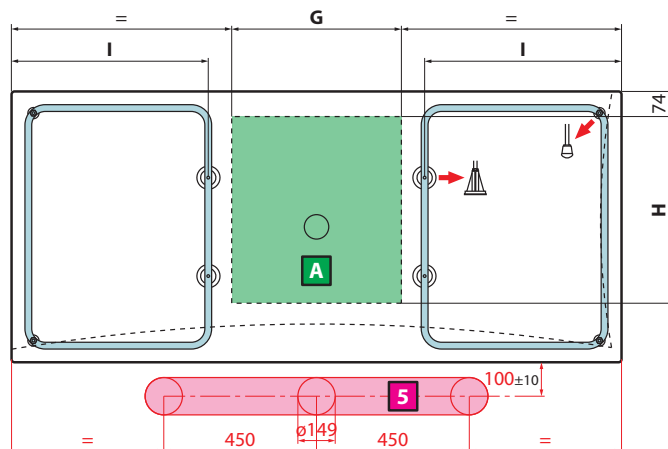
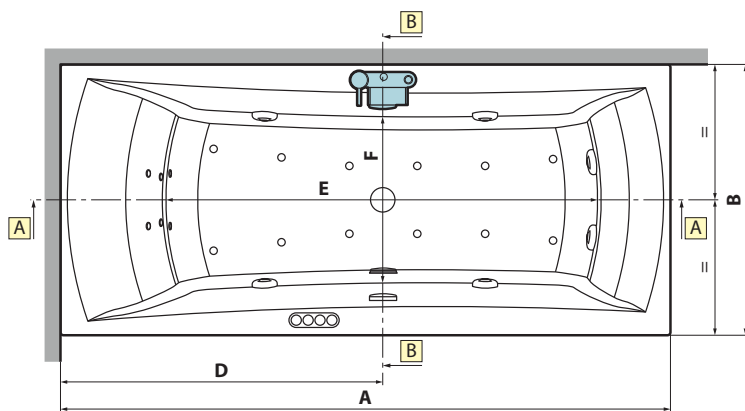
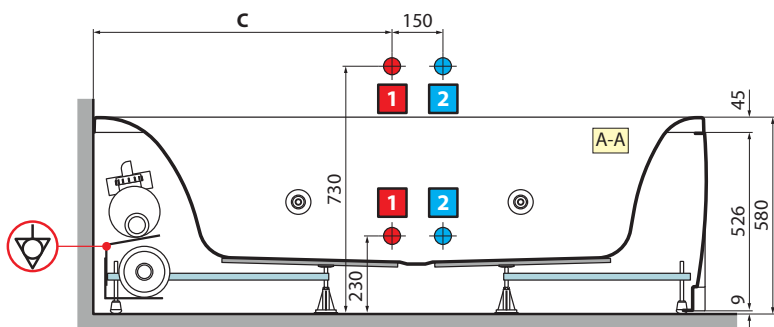

modello	A	B	C	D	E	F	G	H	I	J
<b>170x70</b>	1696	700	870	940	1220	420	450	500	542	500
<b>180x80</b>	1797	798	880	949	1240	490	500	550	580	550
<b>190x80</b>	1897	798	930	1001	1300	440	500	550	580,5	550



Installare a monte dell'apparecchio un interruttore differenziale da 30mA provvisto di interruttore onnipolare con apertura minima dei contatti  $\geq 3$  mm.

## CARATTERISTICHE IDRAULICHE

6 bocchette whirlpool  
12 bocchette airpool  
6 bocchette airpool dorsale  
Allaccio sifone con raccordo 1 1/2"

## CARATTERISTICHE ELETTRICHE

Tensione 220-230 V  
Frequenza 50 Hz  
Potenza massima assorbita: 950 W  
Whirlpool: 550 W  
Airpool: 400 W