

VASCA ANGOLARE

ALLESTIMENTI



HYDRO HYDRO PLUS

TUTTE LE FUNZIONI E DOTAZIONI (disponibili a seconda dell'allestimento)



Airpool
12 jets



Whirlpool
6 jets



Disinfezione

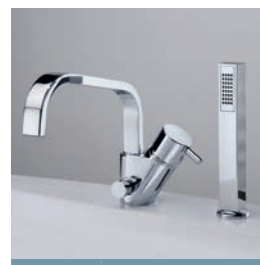

Rubinetteria
bordo vasca



Telecomando
Touch Screen



Telecomando
ON/OFF



Colonna
di scarico

FINITURA VASCA ACRILICO



Bianco lucido

OPTIONAL

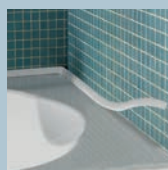

Profilo
di finitura
PRVA2-A



Tubo di scarico
salvagoccia
R90SCDOCBV



Pannello
d'ispezione per
vasca ad incasso
PANISP-A



Colonna di
scarico
COLSCA-K



VASCHE

UNA

VASCA ANGOLARE

Caratteristiche	Misure		Codice	Scelta scarico/erogazione			Scelta struttura / Prezzo	
	cm	H		Colonna di scarico	Colonna di scarico con erogatore	Rubineria bordo vasca	con telaio	1 pannello

STANDARD

DA INCASSO	135 x 135	55	UNA 1 135135-A	-	-	-		
-------------------	-----------	----	-----------------------	---	---	---	---	--



CON TELAIO	135 x 135	55	UNA 2 135135				A0 	A1 
-------------------	-----------	----	---------------------	---	---	--	--	--

HYDRO



CON TELAIO SENZA DISINFEZIONE	135 x 135	55	UNA 5 135135 O				A0K 	A1K 
--------------------------------------	-----------	----	-----------------------	---	---	--	---	---



CON TELAIO E DISINFEZIONE	135 x 135	55	UNA 3 135135 P				A0K 	A1K 
----------------------------------	-----------	----	-----------------------	---	---	--	---	---

HYDRO PLUS



CON TELAIO	135 x 135	55	UNA 4 135135 P				A0K 	A1K 
-------------------	-----------	----	-----------------------	---	---	--	---	---

ESEMPIO COMPILAZIONE CODICE:

UNA4135135PC-A0K

=

UNA4135135P

+

C-

+

A0K



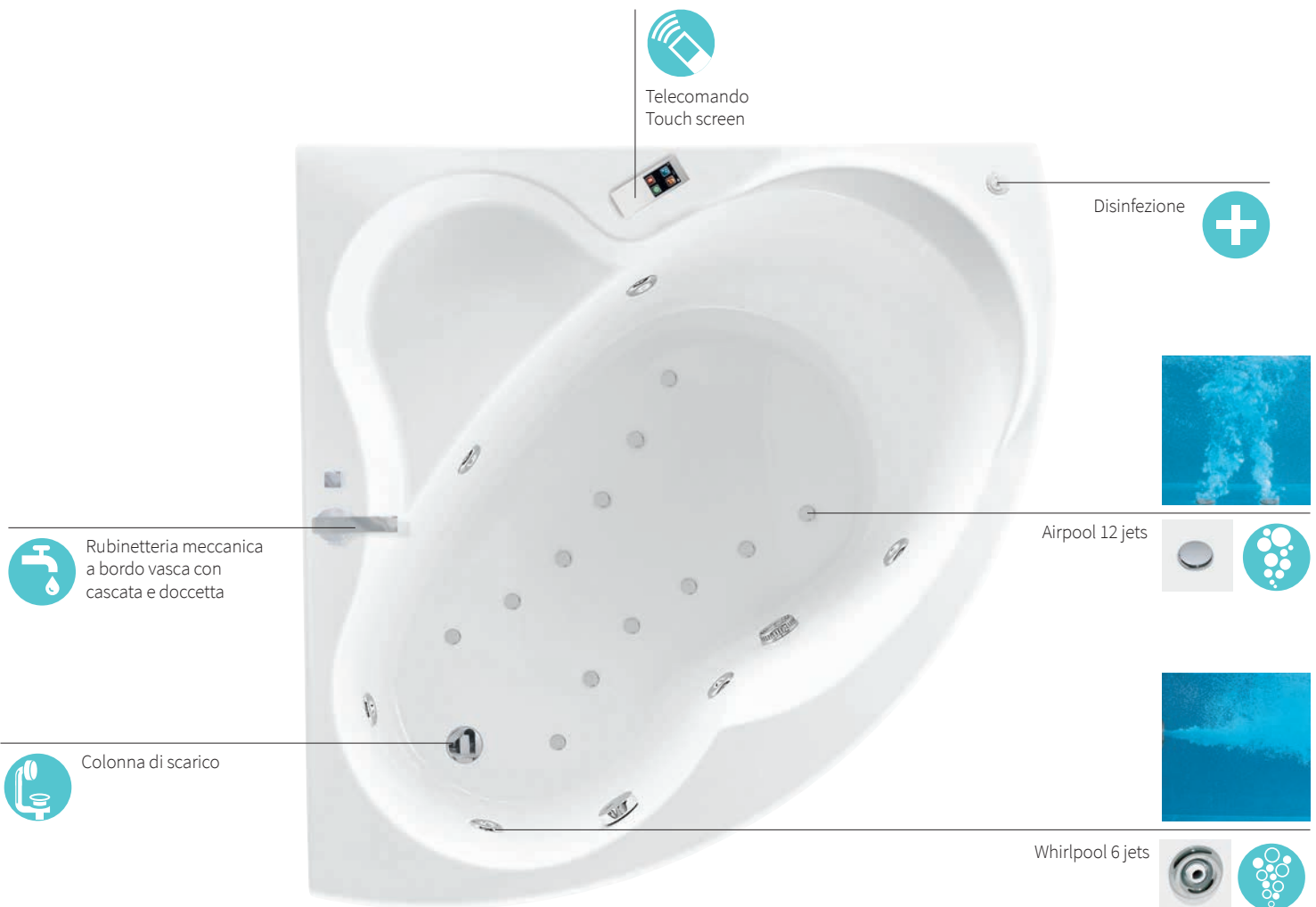

HYDRO PLUS

MASSAGGIO CLASSICO A GETTO D'ARIA E ACQUA/ARIA

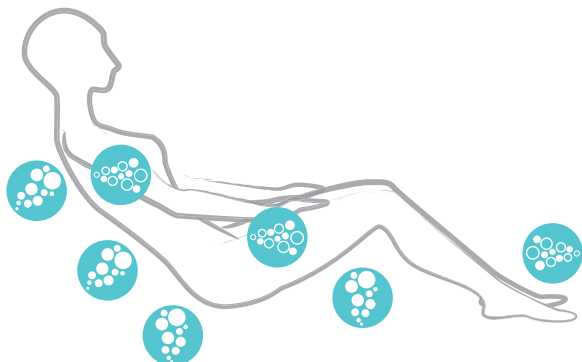

FUNZIONI



 **Massaggio Airpool** a getto d'aria con regolazione manuale on/off o programma sequenziale, per una **efficace stimolazione cellulare**.

 **Massaggio corpo Whirlpool** aria/acqua con regolazione di tempo e intensità manuale o automatica. **L'essenzialità del massaggio Novellini.**

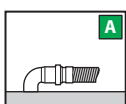
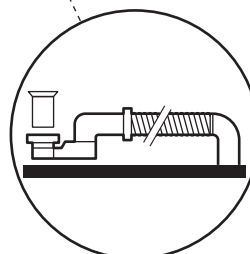
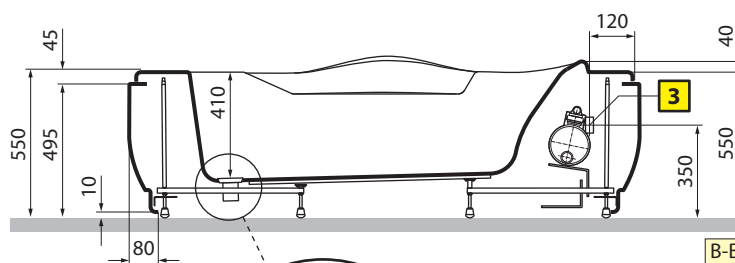
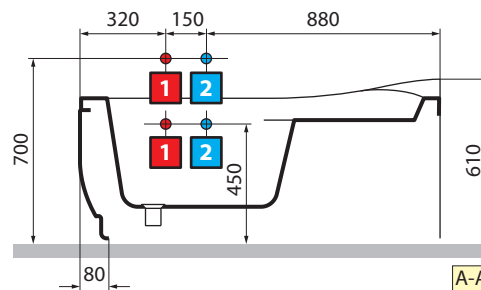
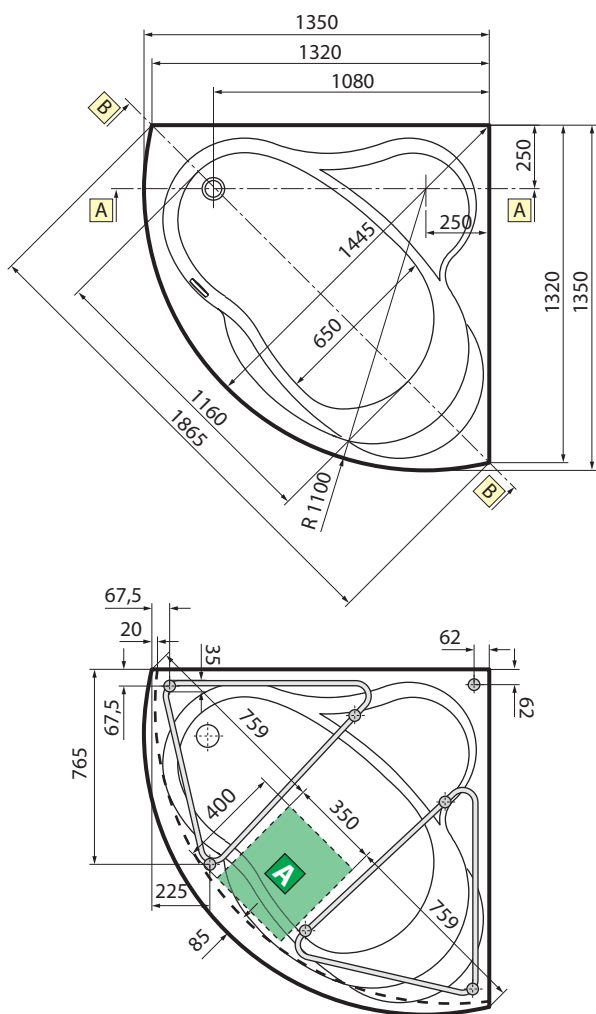

ATTENZIONE!
Può essere dannoso ai portatori di pacemakers

Installare a monte dell'apparecchio un interruttore differenziale da 30mA provvisto di interruttore onnipolare con apertura minima dei contatti ≥ 3 mm.

CARATTERISTICHE IDRAULICHE

6 bocchette whirlpool
12 bocchette airpool
Allaccio sifone con raccordo 1 1/2"

CARATTERISTICHE ELETTRICHE

Tensione 220-230 V
Frequenza 50 Hz
Potenza massima assorbita: 950 W
Whirlpool: 550 W
Airpool: 400 W