

VOGUE



p. 602



150x85 cm 140 lt

165x85 cm 180 lt

VASCA ANGOLARE ASIMMETRICA

ALLESTIMENTI

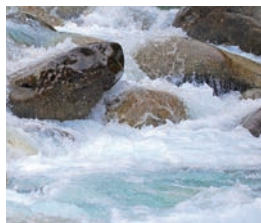

HYDRO HYDRO PLUS

TUTTE LE FUNZIONI E DOTAZIONI (disponibili a seconda dell'allestimento)



 Airpool
12 jets



 Whirlpool
5 jets



 Disinfezione

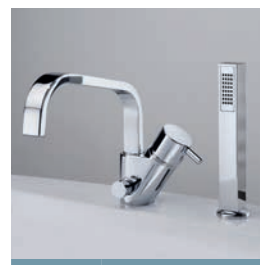

 Rubinetteria
bordo vasca



 Telecomando
Touch Screen



 Telecomando
ON/OFF



 Poggiatesta en
EVA,
impermeabile,
antibatterico ed
atossico



 Colonna
di scarico

FINITURA VASCA ACRILICO



Bianco lucido

OPTIONAL



Poggiatesta in
EVA (solamente
per versione ad
incasso)

POGVOG



Tubo di scarico
salvagoccia

R90SCDOCBV



Pannello
d'ispezione per
vasca ad incasso

PANISP-A



Colonna di
scarico

COLSCA-K

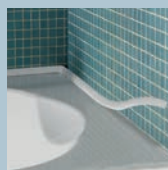

Profilo
di finitura

PRVA2-A

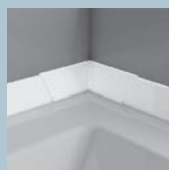

Kit 2 profili di
finitura rigidi in
plastica 195 cm

PRVA195-30



Profilo di finitura
rigido in alluminio

PRV185-30
(1 lato 185 cm)

PRV18585-30
(2 lati 185x85 cm)



VASCHE

VOGUE

VASCA ANGOLARE ASIMMETRICA

Caratteristiche	Misure		Codice	Scelta scarico/erogazione			Installazione		Scelta struttura / Prezzo	
	cm	H		Colonna di scarico	Colonna di scarico con erogatore	Rubinetteria bordo vasca	sinistra	destra	con telaio	1 pannello

STANDARD

DA INCASSO	Misure		Codice	Colonna di scarico	Colonna di scarico con erogatore	Rubinetteria bordo vasca	S-A	D-A	Struttura
	cm	H					sinistra	destra	
	150 x 85	55	VOG 1 15085	-	-	-			
	165 x 85	55	VOG 1 16585	-	-	-			



CON TELAIO	Misure		Codice	C	E	F	S-	D-	A0	A1
	cm	H		Colonna di scarico	Colonna di scarico con erogatore	Rubinetteria bordo vasca	sinistra	destra	Struttura	Struttura
	150 x 85	55	VOG 2 15085							
	165 x 85	55	VOG 2 16585							

HYDRO



CON TELAIO SENZA DISINFEZIONE	Misure		Codice	C	E	F	S-	D-	A0K	A1K
	cm	H		Colonna di scarico	Colonna di scarico con erogatore	Rubinetteria bordo vasca	sinistra	destra	Struttura	Struttura
	150 x 85	55	VOG 5 15085 O							
	165 x 85	55	VOG 5 16585 O							



CON TELAIO E DISINFEZIONE	Misure		Codice	C	E	F	S-	D-	A0K	A1K
	cm	H		Colonna di scarico	Colonna di scarico con erogatore	Rubinetteria bordo vasca	sinistra	destra	Struttura	Struttura
	150 x 85	55	VOG 3 15085 P							
	165 x 85	55	VOG 3 16585 P							

HYDRO PLUS



CON TELAIO	Misure		Codice	C	E	F	S-	D-	A0K	A1K
	cm	H		Colonna di scarico	Colonna di scarico con erogatore	Rubinetteria bordo vasca	sinistra	destra	Struttura	Struttura
	150 x 85	55	VOG 4 15085 P							
	165 x 85	55	VOG 4 16585 P							



• Disponibilità indicativa deposito centrale 7gg.



HYDRO PLUS

MASSAGGIO CLASSICO A GETTO D'ARIA E ACQUA/ARIA



FUNZIONI

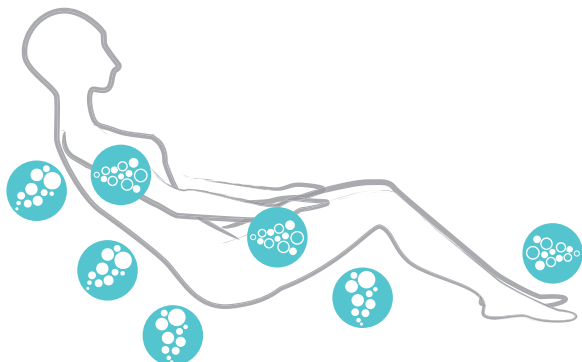

Massaggio Airpool a getto d'aria con regolazione manuale on/off o programma sequenziale, per una **efficace stimolazione cellulare**.



Massaggio corpo Whirlpool aria/acqua con regolazione di tempo e intensità manuale o automatica. **L'essenzialità del massaggio Novellini.**

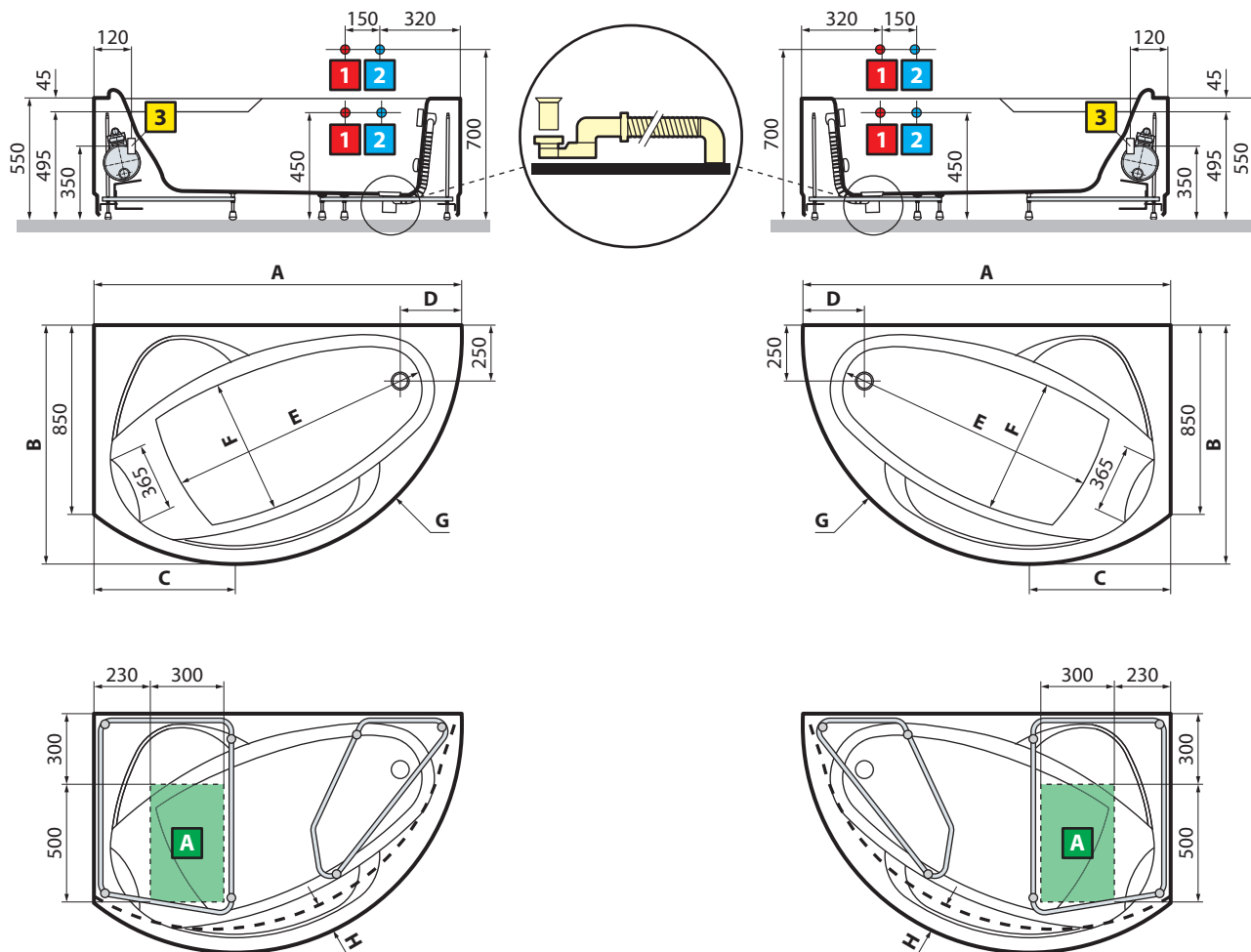

modello	A	B	C	D	E	F	G	H
150x85	1500	1015	550	290	1030	580	962	137
165x85	1650	1070	630	280	1150	640	1015	155

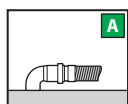

ATTENZIONE!
Può essere dannoso ai portatori di pacemakers

Installare a monte dell'apparecchio un interruttore differenziale da 30mA provvisto di interruttore onnipolare con apertura minima dei contatti ≥ 3 mm.

CARATTERISTICHE IDRAULICHE

5/7 bocchette whirlpool
12 bocchette airpool
Allaccio sifone con raccordo 1 1/2"

CARATTERISTICHE ELETTRICHE

Tensione 220-230 V
Frequenza 50 Hz
Potenza massima assorbita: 950 W
Whirlpool: 550 W
Airpool: 400 W